

NICHIA CORPORATION

SPECIFICATIONS FOR LASER DIODE

Part No. NUBB45

FEATURES

- Typical Optical Output Power: 34.0W
- Typical Dominant Wavelength: 455nm
- Multi-transverse Mode
- Collimated Beam
- RoHS Compliant

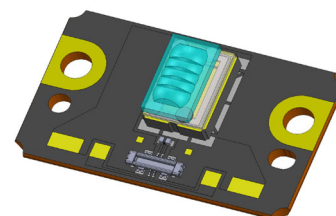

APPLICATIONS



SPECIFICATIONS

(1) Absolute Maximum Ratings

Item	Symbol	Absolute Maximum Rating	Unit
Forward Current ¹	I_F	Figure 1	A
Allowable Reverse Current	I_R	85	mA
Storage Temperature	T_{stg}	-40 ~ 85	°C
Operating Package Temperature ²	T_m	0 ~ 75	°C

¹ The maximum rating provided in Figures 1 should not be exceeded.

As the forward current and/or the operating package temperature become higher, the lifetime of the LD will become shorter.

² See Figure 2 for the measurement point of the operating package temperature (T_m).

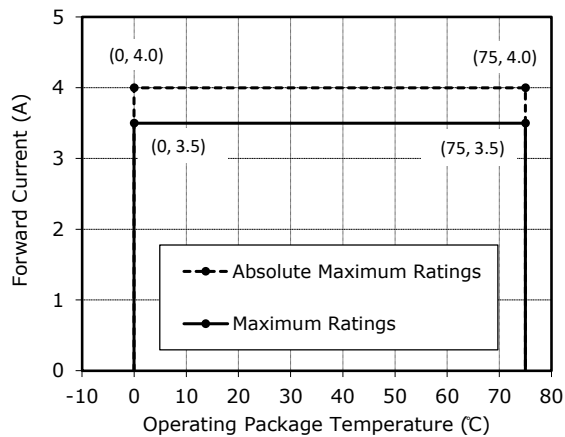

Figure 1. Derating Characteristics

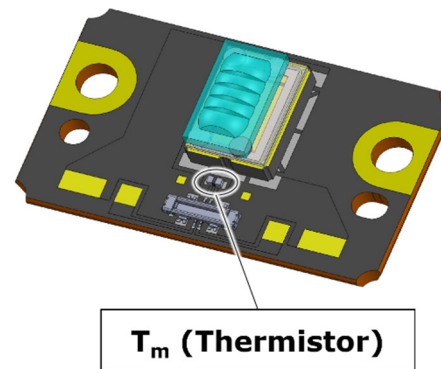

Figure 2. Temperature measurement point

(2) Initial Electrical/Optical Characteristics^{3, 4}

Item	Symbol	Condition	Min.	Typ.	Max.	Unit	
Optical Output Power	P_o	$I_F = 3.5A$	30.5	(34.0)	37.5	W	
Dominant Wavelength ⁵	λ_d	$I_F = 3.5A$	449	(455)	461	nm	
Threshold Current	I_{th}	-	220	-	420	mA	
Slope Efficiency	η	-	-	(10.7)	-	W/A	
Forward Voltage	V_F	$I_F = 3.5A$	17.3	(19.5)	21.6	V	
Beam Pointing Tilt Angle ^{6, 7}	$\Delta\theta$	$I_F = 3.5A$	-	-	1.1	°	
Beam Divergence ⁷	Parallel	$\theta_{//}$	$I_F = 3.5A$	0	(0.8)	1.6	°
	Perpendicular	θ_{\perp}	$I_F = 3.5A$	-1.5	(0)	1.5	°

³ Characteristics values are values measured under Nichia's measurement conditions/environments; there may be variations for the measurement repeatability/reproducibility of these values. The values in parentheses are for reference purposes only.

⁴ Characteristics at $T_m = 25^\circ\text{C}$ and measured in CW mode. See Figure 2 for the measurement points of the operating package temperature (T_m).

⁵ λ_d is calculated from chromaticity coordinate (x, y) values on the chromaticity diagram calculated using the intensities in the region equal to or above $1/e^2$ of the peak intensity shown in Figure 3.

⁶ $\Delta\theta = (\Delta\theta_{//}^2 + \Delta\theta_{\perp}^2)^{1/2}$ ($\Delta\theta$ is the value of the total emission of all the LD chips.)

⁷ Full angle at $1/e^2$ of peak intensity for the total emission of all the LD chips.

(3) Lifetime Characteristics⁸

Item	Symbol	Condition	Min.	Typ.	Max.	Unit
Estimated lifetimes ^{9, 10}	Life	Cumulative Failure Rate = 50%	8000	(20000)	-	h
		Cumulative Failure Rate = 1%	1000	-	-	h

⁸ Values in parentheses are for reference purposes only.

⁹ Operating conditions: $T_m = 75^\circ\text{C}$, $I_f = 3.5\text{A}$ (CW) in ACC (automatic current control) mode.

¹⁰ How the lifetime is determined: Linearly extrapolated from the reduction ratio of the optical output power calculated at 1000 hours of operation for each LD.

Failure criteria: $\leq \text{Initial } P_o \times 0.5$

Sample size for the cumulative failure rate calculation: ≥ 500 LDs.

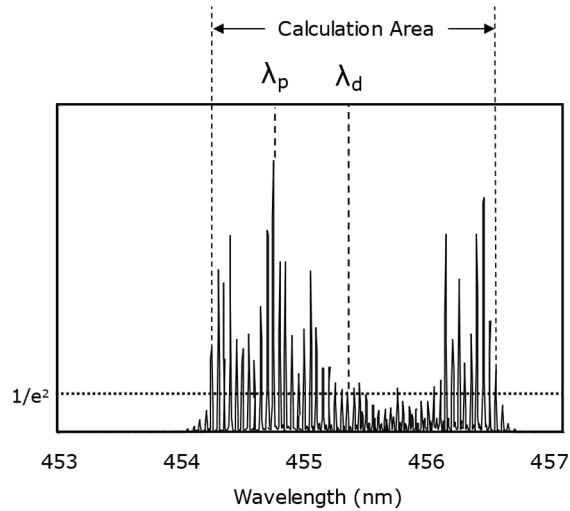

Figure 3. Definition of the Dominant Wavelength

WEIGHT

The weight of the LD is 5.7g (Typ.).

OUTLINE DIMENSIONS

No. UTZ-ZA09000
(単位 Unit: mm)

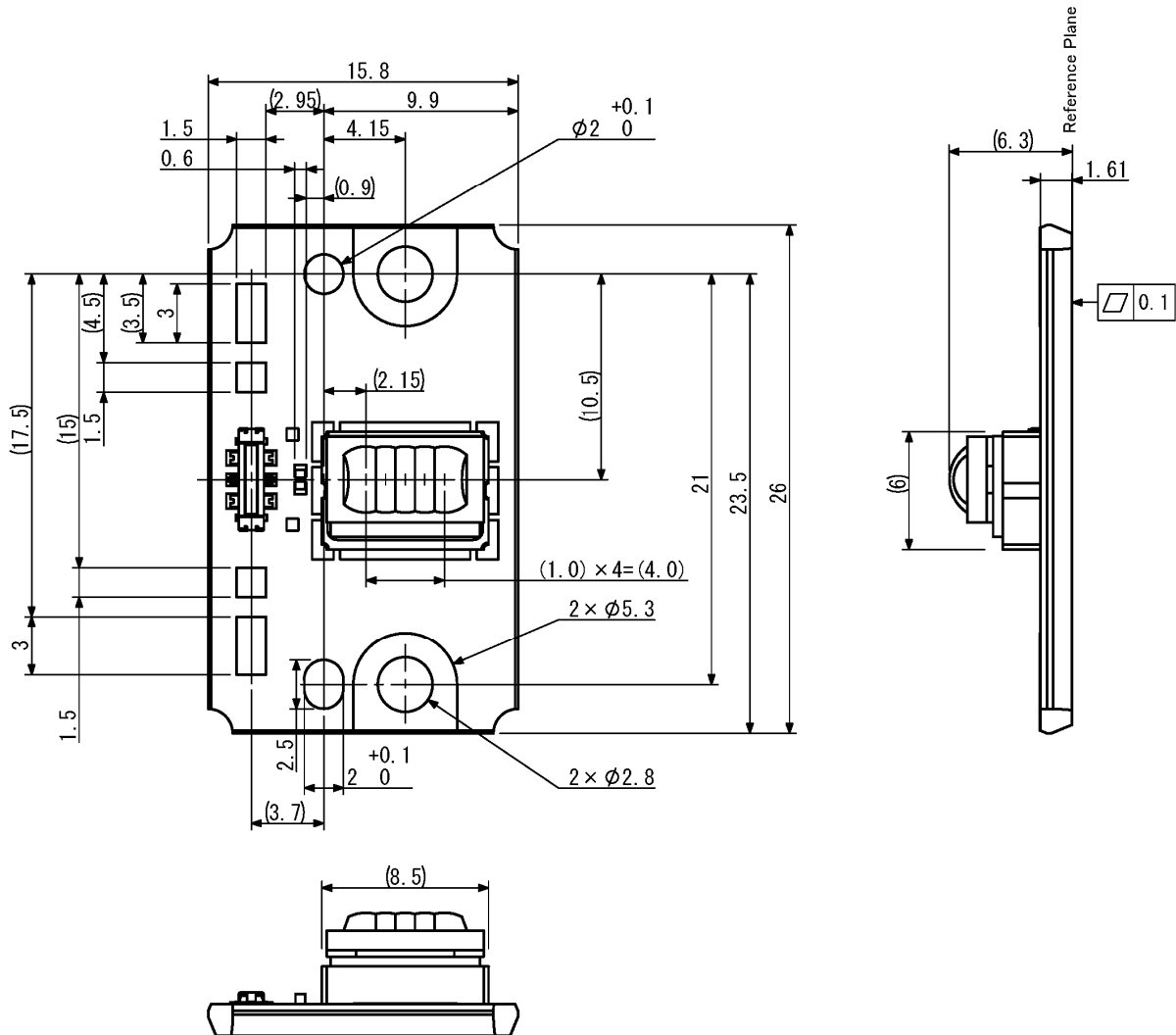

括弧で囲まれた寸法は参考値です。
The dimension(s) in parentheses are for reference purposes

注記
特に明記していない限り、図面の公差は JIS B 0405-mに
準拠しています。下の表を参照してください。

Note:
Unless otherwise specified, the tolerances on the drawings
comply with JIS B 0405-m. See the table below.

表. 長さ寸法の公差 (単位: mm)
Table: Tolerances for the linear dimensions (Unit: mm)

Size Range	0.5 to 3	above 3 to 6	above 6 to 30
Tolerance	±0.1	±0.1	±0.2

OUTLINE DIMENSIONS (CONT.)

No. UTZ-ZA09000

LDチップの位置番号
LD Chip Location Number

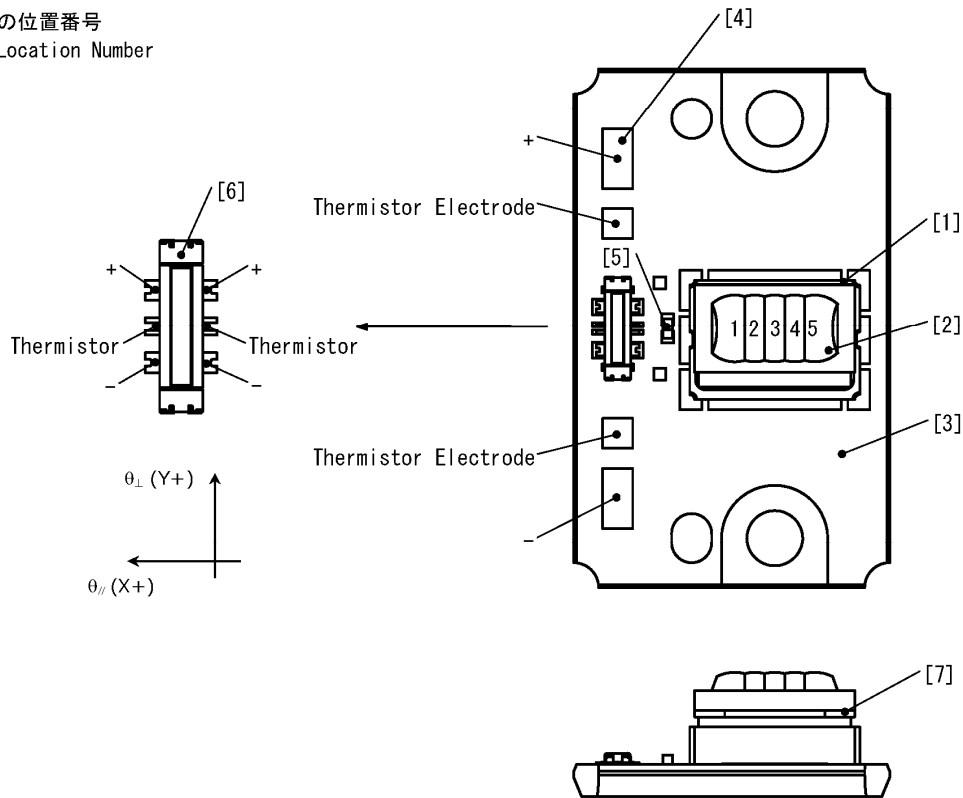

番号 No.	部品名	Component Name	材質	Material
[1]	パッケージ	Package	セラミックス + 硬質ガラス	Ceramics + Hard Glass
[2]	レンズアレイ	Lens Array	光学ガラス	Optical Glass
[3]	基板	Copper Substrate	銅	Copper
[4]	電極	Electrode	金めっき	Au Plating
[5]	サーミスタ	Thermistor	セラミックス	Ceramics
[6]	コネクタ	Connector	樹脂 + 銅合金 + 金めっき	Resin + Cu Alloys + Au Plating
[7]	レンズ固定接着剤	Adhesive	樹脂	Resin

部品 Component Name	製造業者 Manufacturer	型名 Part No.
コネクタ Connector	日本航空電子工業株式会社 Japan Aviation Electronics Industry, Ltd.	WP10-P004VA12-R15000

駆動回路
Drive Circuit

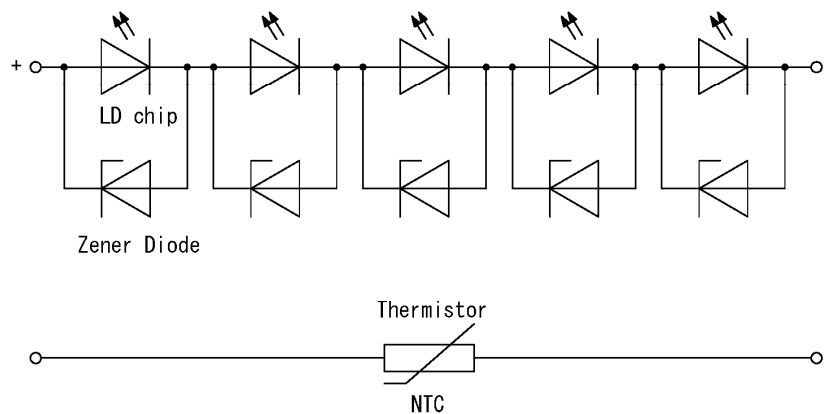

PACKAGING

● Inner Packaging

帯電防止防湿袋(真空パック)^{1, 2}
Antistatic, moisture-proof bag
(Vacuum packing)

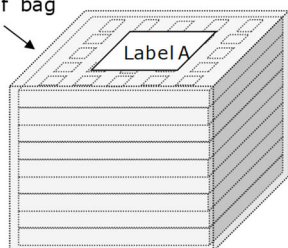

最大9トレイ(内カバー用1トレイ)
9 Trays max. (including 1 cover tray)
L:260 x W:220 x H:92 (mm)

Label A: Laser warning label



1トレイにつき最大25個
Number of LDs per tray: 25 LDs (max.)

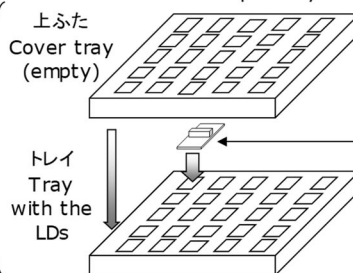

(日亜型番)
(Nichia Part No.)
(日亜管理番号)
(Nichia Reference No.)

Label B: Box Shipping label

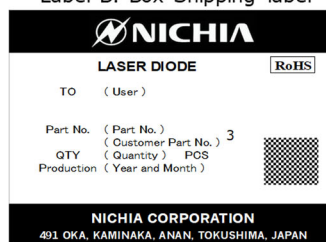

● Outer Packaging

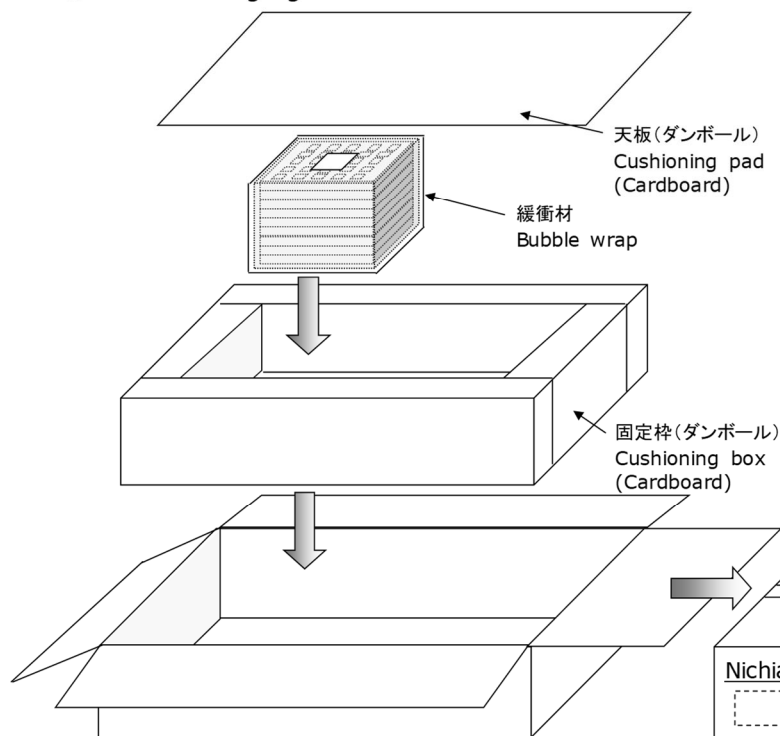

天板(ダンボール)
Cushioning pad
(Cardboard)

緩衝材
Bubble wrap

固定枠(ダンボール)
Cushioning box
(Cardboard)

- 1 LD個数/袋: 200個(最大)
Number of LDs per bag: 200 LDs (max.)
- 2 トレイ数/袋: 8トレイ(最大)と最上段にカバー用トレイ
Number of trays per bag: 8 trays (max.)
with a cover tray on top
- 3 要望があった場合のみ、顧客型番をラベルに印刷します。
The Customer Part No. will only be included on the labels when specifically requested.
- 4 袋数/ダンボール: 2袋(最大)
袋は重ねず、横に並べてダンボールに入れます。
Number of bags per cardboard box: 2 bags (max.)
The bags are placed side-by-side in the cardboard box, not stacked on top of each other.
- 5 LD個数/ダンボール: 400個(最大)
Number of LDs per cardboard box: 400 LDs (max.)

Nichia LD
Label B

外箱(ダンボール) Outer Box (Cardboard)^{4, 5}
L: 350 x W: 560 x H: 140 (mm)

- 本製品はトレイを帯電防止防湿袋でパックしたのち、輸送の衝撃から保護するためダンボールで梱包します。
The LDs shipped in trays are packed in an antistatic, moisture-proof bag.
They are shipped in the cardboard box to protect them from external forces during transportation.
- 取り扱いに際して、落下させたり、強い衝撃を与えたりしますと、製品を損傷させる原因になりますので注意してください。
Do not drop or expose the box to external forces as it may damage the LDs.
- ダンボールには防水加工がされていないので、梱包箱が水に濡れないように注意してください。
Do not expose the cardboard box to water as it is not water-resistant.
- 輸送、運送に際して弊社梱包状態あるいは同等の梱包を行ってください。
Using the original packaging materials or equivalent in transit is recommended.

ELECTRICAL/OPTICAL CHARACTERISTICS

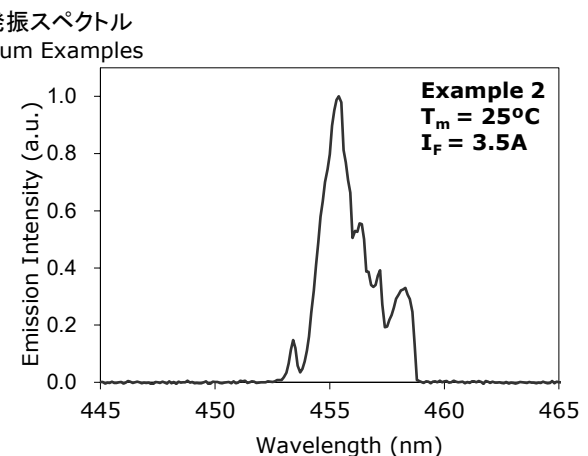
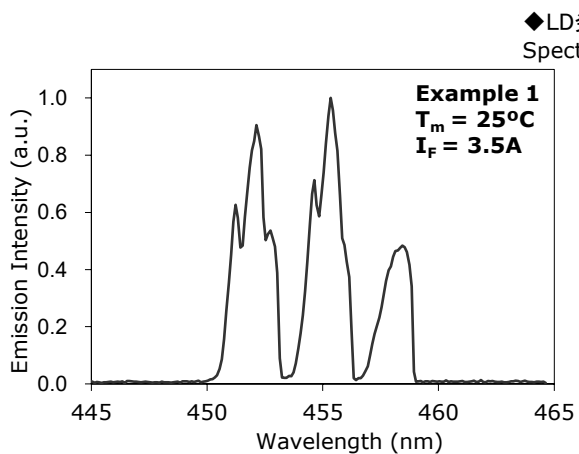
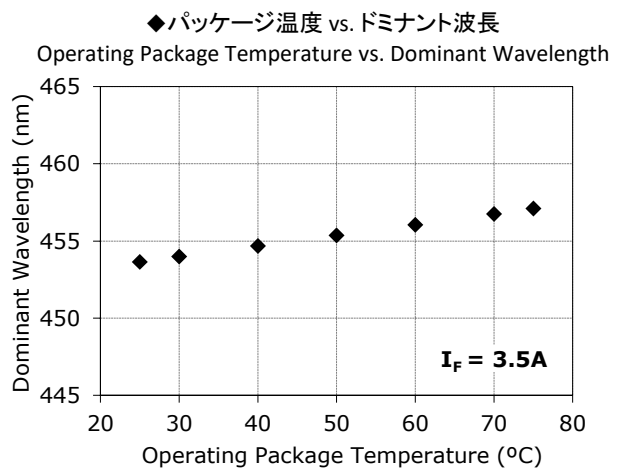
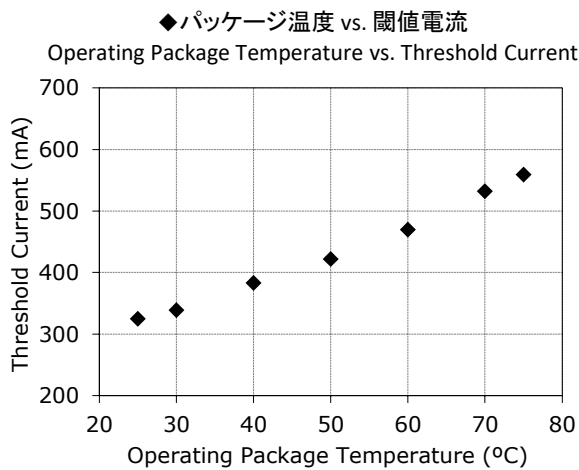
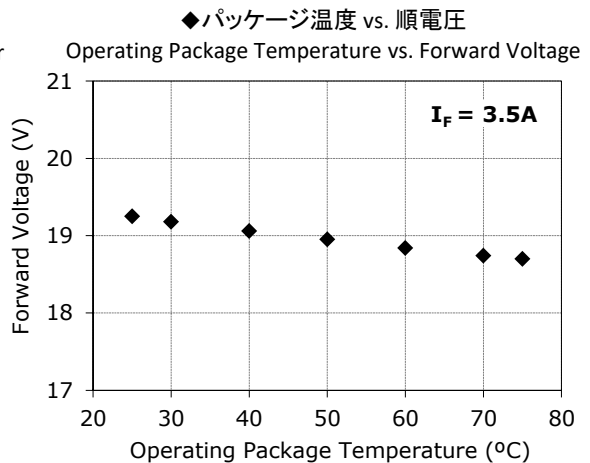
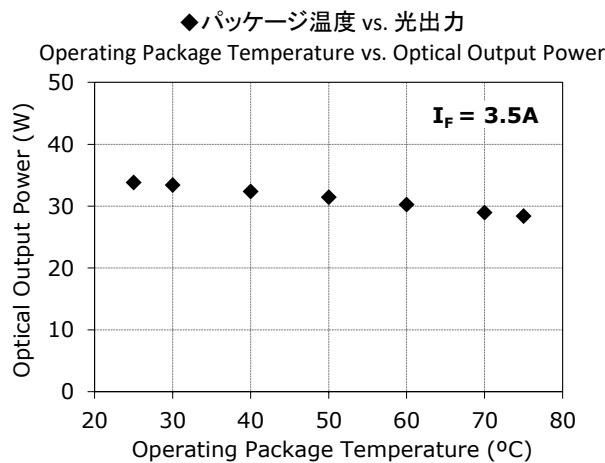
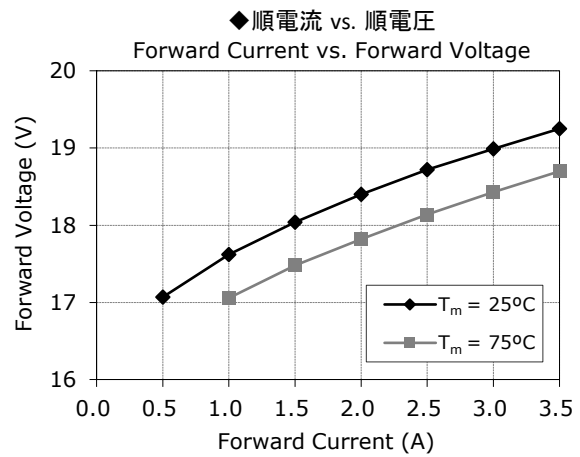
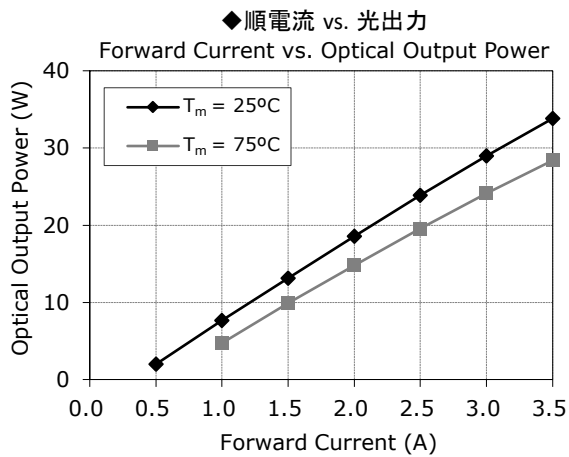

RELIABILITY

(1) Test Items and Conditions

Test	Test Conditions	Test Duration	Reference Standard	Failure Criteria #
Temperature Cycle	-40°C (15min) ~85°C (15min)	100 Cycles	JEITA ED-4701/100A 105A	1
Vibration	200m/s ² , 20~2000~20Hz, 4 cycles, 4min, each X, Y, Z	48 minutes	JEITA ED-4701/400A 403A	1
Shock	15000m/s ² , 0.5ms, each X, Y, Z	5 times	JEITA ED-4701/400A 404A	1
High Temperature Storage	T _A = 85°C	1000 hours	JEITA ED-4701/200A 201A	1
Temperature Humidity Storage	T _A = 85°C, RH = 85%	1000 hours	JEITA ED-4701/100A 103A	1
Low Temperature Storage	T _A = -40°C	1000 hours	JEITA ED-4701/200A 202A	1
Operating Life	T _m = 75°C, I _F = 3.5A (CW) in ACC (automatic current control)	1000 hours		2

(2) Failure Criteria

Criteria #	Items	Conditions	Failure Criteria
1	Forward Voltage (V _F)	T _m = 25°C, I _F = 3.5A (CW)	<Initial Value ×0.9 >Initial Value ×1.1
	Optical Output Power (P _O)		<Initial Value ×0.9 >Initial Value ×1.1
	Beam Pointing Tilt Angle (Δθ)		<Initial Value -0.5° >Initial Value +0.5°
2	Optical Output Power (P _O)	T _m = 75°C, I _F = 3.5A (CW)	<Initial Value ×0.9 >Initial Value ×1.1

CAUTIONS

When using this LD for the chosen application (e.g. equipment, devices, etc.), design for safety must be considered to ensure that any LD failure does not cause any injuries to the human body and/or damage to property.

This LD can fail at a certain rate. The failure rate and/or failure mode of the LD can vary depending on several factors (e.g. circuit, environmental conditions, etc.). In this LD, the lens array is attached to the hermetic sealing cover using adhesive(s). The adhesion strength is sufficient for the operating conditions within the specifications described in this specification. However, the lens array might be removed/shifted depending on the environments and/or the design of the chosen application where the LD is operated, etc. In order to maintain the reliability of the product, the following issues must be considered when using it.

(1) Laser Hazard

- This LD is a laser diode classified as Class 4 per JIS C 6802, IEC 60825-1, and FDA/CDRH 21 CFR Part 1040.10; this is the most hazardous class. Ensure that the latest editions of IEC 60825-1 and/or applicable standards for general safety requirements and guidance for laser products are complied with.
- There is a risk of serious injury to the skin/eyes if they are exposed to the LD light. Even diffused/reflected light is harmful. It must be ensured that the maximum permissible exposure is not exceeded; use proper safety glasses for the wavelength and optical output power of the LD.
- This LD emits collimated light. Collimated light propagates over a long distance while maintaining a high energy density; the skin/eyes must not be exposed to the light.

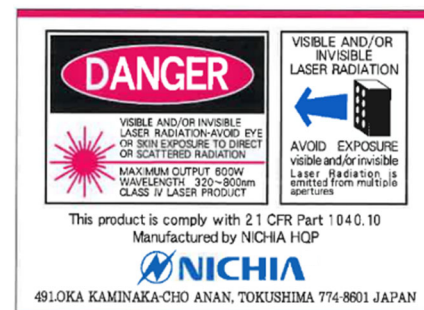

(2) Storage

- To avoid condensation, the LDs must not be stored in areas where temperature and humidity fluctuate greatly both before and after opening the antistatic, moisture-proof bag. The LDs must be stored under an environment of 5-35°C, 40-75% RH.
- This LD has plated parts. If the LDs are exposed to a corrosive environment, it may cause the plated surface to tarnish causing issues (e.g. electric connection failures). Once the antistatic, moisture-proof bag is opened, ensure that the LDs are assembled into the chosen application/heatsink immediately; if they are not used immediately, they must be stored in a hermetically sealed container (e.g. the original antistatic, moisture-proof bag).
- Do not store the LDs in a dusty environment.
- Do not expose the LDs to direct sunlight and/or an environment over a long period of time where the temperature is higher than normal room temperature.
- Ensure that the LDs are stored under conditions/environments detailed above and assembled into the chosen application/heatsink within a year of the receipt of the LD.

(3) Design Consideration

- Since the lifetime of the LD will become shorter as the operating current and/or the optical output power becomes larger, the maximum ratings provided in Figure 1 should not be exceeded.
- This LD is a semiconductor device that has a high current density during operation in the emission layer. Exceeding the Absolute Maximum Ratings may damage the LD. The circuit must be designed to ensure that the Absolute Maximum Ratings (see Absolute Maximum Ratings and Figure 1) are not exceeded even if the LDs are operated only for a short period of time.
- This LD should be operated in an automatic current control (ACC) circuit. Additionally, the circuit to operate the LDs should be designed taking into consideration the current rise time. If no measures are incorporated into the circuit and the current rise time is too short, even though there seems to be no issues (e.g. inrush current, etc.) with the waveform of the current when observed with an oscilloscope, it may cause the LDs to emit excessive light resulting in it being damaged.
- When the LD is operated in ACC mode, if it is operated at a higher operating package temperature (T_m), the optical output power of the LD will become lower, and the lifetime of the LD will become shorter; ensure that the thermal design of the chosen application is appropriate for the required heat dissipation performance.
- The forward voltage (V_f) and the optical output power vary depending on the operating package temperature (T_m). Additionally, the optical output power will gradually decrease over time as the operating time increases. To stabilize the optical output power, an automatic power control (APC) system could be used; in this system, the operating current is automatically adjusted by monitoring the feedback from the photo diode incorporated in the chosen application. If the LD is operated in APC mode, it will be the Customer's responsibility to perform sufficient verification prior to use to ensure that there are no issues.
- When the power supply is turned on or off, the circuit may have issues (e.g. chattering, current spikes, inrush current, etc.) resulting in the Absolute Maximum Rating Current being exceeded. The circuit must be designed to prevent this from occurring.
- The failure modes for this LD can be either a short circuit or an open circuit and this is very important to understand when designing the circuit. If the LD chips become short-circuited during operation, the forward voltage (V_f) may fluctuate resulting in damage to the circuit. To ensure that there are no issues with the designed circuit when these failure modes occur in the LDs, perform a sufficient verification prior to use. This verification should be performed taking into consideration the conditions/environments in which the end-product containing these LDs will actually be used.
- In this LD, the lens array is attached to the hermetic sealing cover using adhesive(s). The adhesion strength is sufficient for the operating conditions within the specifications described in this specification. However, the lens array might be removed/shifted depending on the environments and/or the design of the chosen application where the LD is operated, etc. If the lens array becomes removed/shifted during operation, uncollimated light may be emitted and/or the direction of the laser light emission may be affected causing the light to hit an unintended place/object resulting in the occurrence of smoke, fire, and leakage of laser light; for safety, the chosen application must be designed to prevent the leakage of light and to de-energize the LD when uncollimated light is emitted and/or the light is emitted in an unintended direction.

- Depending on the environments where the LDs are operated, dust/particles may be attracted by the light of the LDs (i.e. optical dust collection effect) and adhere to the surface of the lens array resulting in an adverse effect on the optical characteristics.

(4) Handling Precautions

- This LD is hermetically sealed; ensure that excessive force is not applied to the package when handling the LDs. If the hermetic sealing cover is damaged, the hermetic seal for the LD may fail causing reduction in the optical output power and/or change in the shape of the beam to be accelerated and eventually the LD not to illuminate. Note that if the LD is dropped, it may also break the hermetic seal for the LD.
- Ensure that excessive force is not applied to this LD. Otherwise, it may cause the copper substrate and/or the package to be deformed and/or damaged resulting in the characteristics of the LD not to meet the specification.
- Do not solder the copper substrate of this LD directly to a heatsink.
- This LD is designed to be electrically connected to the chosen application using the connector; Nichia does not recommend making an electrical connection by soldering. If the LD is electrically connected to the chosen application with a method other than using the connector (i.e. soldering), it will be the Customer's responsibility to perform sufficient verification prior to use to ensure that there are no issues.
- Do not apply an external force of $\geq 40\text{N}$ to the connector. This may cause the connector to be damaged.
- During and after attaching a connector (i.e. receptacle) to the connector on the LD (i.e. the plug), ensure that excessive external force is not applied to the connectors; it may cause the connectors to be damaged.

(5) Shape of the Beam

- This LD emits elliptical-shaped parallel light through the lens array. Adjust the shape of the beam emitted from the LD with a lens that is suitable for the chosen application when using the LD.
- Ensure that the lens array is not damaged/contaminated when handling the LDs. Otherwise, this may reduce the optical output power and/or change the shape of the beam.
- The lens array is attached to the hermetic sealing cover using adhesive(s). The lens array might be removed/shifted if the LD is operated under high temperature and high humidity conditions, or the reflected light continuously hits the lens array and/or adhesive; this may change the shape of the beam.

(6) Electrostatic Discharges (ESD) and Electrical Surges

- This LD is sensitive to transient excessive voltages (e.g. ESD, lightning surge). If this excessive voltage occurs in the circuit, it may cause the LD chip to be damaged causing issues (e.g. the LD chip to become dimmer or not to illuminate). Ensure that when handling the LDs, necessary measures are taken to protect them from ESD. The following examples are recommended measures to eliminate the charge:
 - Wearing antistatic clothes, gloves, shoes, etc.
 - Grounded wrist straps with a $1\text{M}\Omega$ resistor
 - Grounded workstation equipment and tools
 - Using the original antistatic shipping tray for transport/storage
- Ensure that all necessary measures are taken to prevent the LD from being exposed to transient excessive voltages (e.g. ESD, lightning surge):
 - tools, jigs, and machines that are used are properly grounded
 - appropriate antistatic materials/equipment are used in the work area
 - the system/assembly is designed to provide ESD protection for the LDs against transient excessive voltages
- Grounding insulators neither removes nor prevents surface charges. If the tool/equipment used is an insulator (e.g. glass cover, plastic, etc.), ensure that necessary measures have been taken to protect the LD from transient excessive voltages (e.g. ESD). The following examples are recommended measures to eliminate the charge:
 - Dissipating static charge with conductive materials
 - Preventing charge generation with moisture
 - Neutralizing the charge with ionizers
- In work environments with a RH of $\leq 40\%$, ESD events are more likely to occur. When handling/assembling the LDs, it should be performed in an environment with the proper humidity level.
- Do not connect/disconnect any devices (e.g. oscilloscope probes, voltage meter cables, etc.) while the LDs are energized. Otherwise, this may cause an electrical surge resulting in the LDs being damaged.
- High-frequency noises could induce a surge into the circuit, causing an excessive current to flow. Do not use the LDs near devices that produce high-frequency noises (e.g. glow discharge tube, etc.).

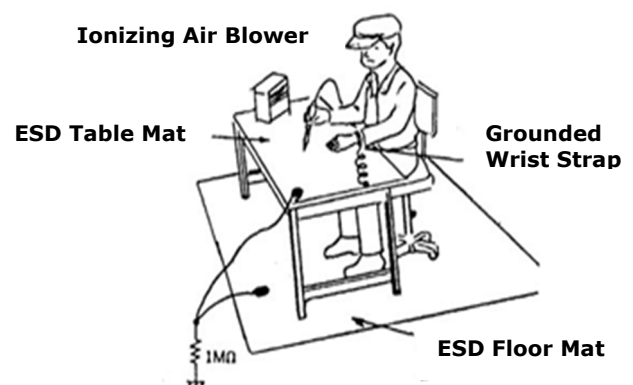

(7) Thermal Management

- The temperature of the LDs while in operation may vary depending on the thermal resistance of the heatsink and other materials (e.g. thermal interface materials, etc.), the condition of the contact surface of the heatsink (e.g. holes/opening, cavities/recesses, foreign materials, etc.), and how the LDs are attached to the heatsink (e.g. with/without grease, etc.). Once the heatsink and other materials are selected, sufficient verification should be performed to ensure that adequate adhesion is achieved, and that the Absolute Maximum Operating Package Temperature (T_m) is not exceeded.
- When thermal grease is used, ensure that it does not adversely affect the electrical characteristics of the LD and that the volatile compounds from the grease do not have an effect on the optical characteristics.

(8) Thermistor

- If the power consumed by the thermistor exceeds the maximum power dissipation detailed in the Appendix, the self-heating of the thermistor may become large causing the thermistor not to detect the ambient temperature properly and/or the thermistor may become excessively hot resulting in the thermistor being damaged; when designing the circuit, necessary measures should be taken to protect the thermistor from excessive voltage, etc. for safety.

LIMITED WARRANTY

- Nichia warrants that the LDs will meet the requirements/criteria as detailed in the RELIABILITY section within this specification. If the LDs are used under conditions/environments deviating from or inconsistent with those described in this specification, the resulting damage and/or injuries will not be covered by this warranty.
- Nichia warrants that the quality of the LDs that are manufactured and/or supplied by Nichia will be as detailed within this specification; it is the Customer's responsibility to perform a sufficient verification prior to use to ensure that the lifetime and other quality characteristics required for the intended use are met.
- This LD is intended to be used for household appliances and electronic devices (e.g. mobile communication devices) laser diodes have been used in; it is not designed or manufactured for use in applications that require safety critical functions (e.g. automobiles, trains, vessels, aircraft, spacecraft, submarine repeaters, nuclear reactor control systems, traffic control equipment, combustion equipment, life support systems, safety devices, etc.). If the LDs are planned to be used for these applications, unless otherwise detailed in the specification, Nichia will neither guarantee that the LD is fit for that purpose nor be responsible for any resulting property damage, injuries and/or loss of life/health. This LD does not comply with IATF 16949 and is not intended for automotive applications.
- The applicable warranty period is one year from the date that the LD is delivered.

RETURN POLICY FOR NON-CONFORMING LDs

In the event that the LD is found not to conform to the foregoing specifications within a year of the receipt of the LD, Nichia will be subject to the procedure set forth below:

- Nichia will provide the replacement for the non-conforming LD or an equivalent item, or refund at Nichia's discretion, provided that the Customer
 - (1) promptly notifies Nichia in writing of the details of the non-conformity,
 - (2) ships the non-conforming LD at the Customer's expense to Nichia for examination, and
 - (3) the non-conformity is specifically attributable to Nichia and not due to mishandling or misuse by the Customer.
- Once Nichia has received both information and the non-conforming LD pursuant to item (2) of the foregoing clause, Nichia will conduct a thorough investigation to provide the Customer with feedback.
- THE REMEDIES PROVIDED IN CLAUSE 1 OF THIS SECTION ARE THE EXCLUSIVE REMEDIES AVAILABLE TO THE CUSTOMER IN RESPECT OF THE BREACH OF THE WARRANTY CONTAINED HEREIN, AND IN NO EVENT SHALL NICHIA BE RESPONSIBLE FOR ANY INDIRECT, INCIDENTAL OR CONSEQUENTIAL LOSSES AND/OR EXPENSES (INCLUDING LOSS OF PROFIT) THAT MAY BE SUFFERED BY THE CUSTOMER ARISING OUT OF A BREACH OF THE WARRANTY.

MISCELLANEOUS

- The Customer must perform a receiving inspection within two weeks of the receipt of the LD.
- Without prior written permission from Nichia, the Customer will not reverse engineer, disassemble or otherwise attempt to extract knowledge/design information from the LD. In the case of any incident that appears not to conform to the foregoing specifications, the local Nichia sales representative should be notified to discuss instructions on how to proceed while ensuring that the LD in question is not disassembled.
- All copyrights and other intellectual property rights in this specification in any form are reserved by Nichia or the right holders who have granted Nichia permission to use the content. Without prior written permission from Nichia, no part of this specification may be reproduced in any form or by any means.
- Both the Customer and Nichia will agree on the official specifications for the supplied LDs before any programs are officially launched. Without this agreement in writing (i.e. Customer Specific Specification), changes to the content of this specification may occur without notice (e.g. changes to the foregoing specifications and appearance, discontinuation of the LDs, etc.).

APPENDIX

Thermistor's Resistance vs. Temperature Characteristics

The following data is based on the specification/technical documents provided by the manufacturer of the thermistor. Use the data for reference purposes only.

Item	Value	Tolerance
Resistance	10k (Ω)	±1%
B Constant (B25/50)	3370 (K)	±1%
B Constant (B25/85)	3413 (K)	-
Maximum Power Dissipation	240 (mW)	-
Dissipation Constant	2.4 (mW/°C)	-

How to Calculate the B Constant

The B constant is a value representing the R_{0TH} vs. T_{TH} relationship of a thermistor and can be calculated using R_{0TH} values at two given ambient temperatures.

$$B = \ln(R/R_0)/(1/T-1/T_0)$$

R: R_{0TH} at $T_A=T$, R_0 : R_{0TH} at $T_A=T_0$
 T, T_0 : Ambient temperatures (T_A) (K)

T[°C]	R[Ω]	T[°C]	R[Ω]	T[°C]	R[Ω]	T[°C]	R[Ω]
0	27,111	26	9,634	51	4,038	76	1,887
1	25,989	27	9,283	52	3,909	77	1,835
2	24,917	28	8,946	53	3,785	78	1,783
3	23,895	29	8,623	54	3,666	79	1,734
4	22,920	30	8,314	55	3,551	80	1,686
5	21,988	31	8,017	56	3,440	81	1,640
6	21,099	32	7,733	57	3,334	82	1,595
7	20,250	33	7,460	58	3,231	83	1,552
8	19,438	34	7,198	59	3,132	84	1,510
9	18,664	35	6,947	60	3,036	85	1,469
10	17,923	36	6,705	61	2,944	86	1,430
11	17,216	37	6,474	62	2,855	87	1,392
12	16,539	38	6,251	63	2,769	88	1,355
13	15,893	39	6,038	64	2,686	89	1,319
14	15,274	40	5,832	65	2,606	90	1,285
15	14,683	41	5,635	66	2,529	91	1,251
16	14,117	42	5,446	67	2,454	92	1,219
17	13,576	43	5,264	68	2,382	93	1,187
18	13,058	44	5,089	69	2,313	94	1,157
19	12,562	45	4,921	70	2,245	95	1,127
20	12,087	46	4,759	71	2,181	96	1,099
21	11,633	47	4,604	72	2,118	97	1,071
22	11,198	48	4,454	73	2,057	98	1,044
23	10,781	49	4,310	74	1,999	99	1,018
24	10,382	50	4,171	75	1,942	100	992
25	10,000						

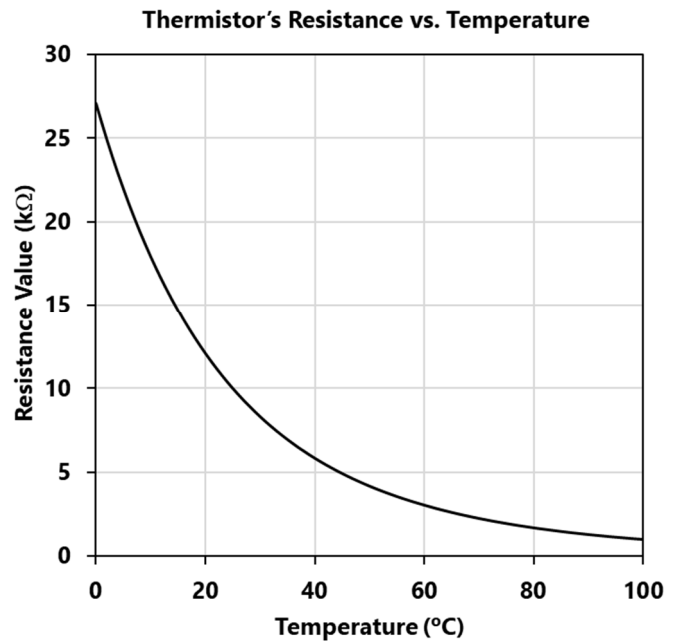

Confidential Data - (Reference Purpose Only.)