



Laser Diode ZBD-LD-647-2700M-F91-M02

ZBD-LD-647-2700M-F91-M02 is a multimode laser diode with 2.7W CW output power at 647nm. Its beam pattern is linear with $9^\circ \times 1^\circ$ ($\theta_{//} \cdot \theta_{\perp}$). This product utilises a 9-millimetre floating-mount TO package. The laser diode is suitable for opto-electronic applications.

■ Absolute Maximum Ratings

Item	Symbol	Absolute Maximum Rating	Unit
Forward Current($T_c=25^\circ\text{C}$)	I_f	3.8	A
Revers Current($T_c=25^\circ\text{C}$)	$I_r(\text{LD})$	85	mA
Storage Temperature	T_{stg}	-40~85	$^\circ\text{C}$
Operating Case Temperature	T_c	0~55	$^\circ\text{C}$

■ Initial Electrical/Optical Characteristics ($T_c=25^\circ\text{C}$)

Parameter	Symbol	Test Condition	Min	Typ	Max	Unit	
Optical Output Power	P_o	$I_f = 3.2\text{A}$	2.3	(2.7)	3.1	W	
Dominant Wavelength	λ_d	$I_f = 3.2\text{A}$	635	(647)	643	nm	
Threshold Current	I_{th}	CW	400	-	650	mA	
Operating Voltage	V_{op}	$I_f = 3.2\text{A}$	1.8	-	2.8	V	
Slope Efficiency	η	CW	-	(4.0)	-	W/A	
Beam Divergence*	Parallel	$\theta_{//}$	$I_f = 3.2\text{A}$	7	(9)	11	$^\circ$
	Perpendicular	θ_{\perp}	$I_f = 3.2\text{A}$	0.8	(1)	1.2	$^\circ$

()are reference figures.

*Full angle at $1/e^2$ from peak intensity



■ Beam Pattern

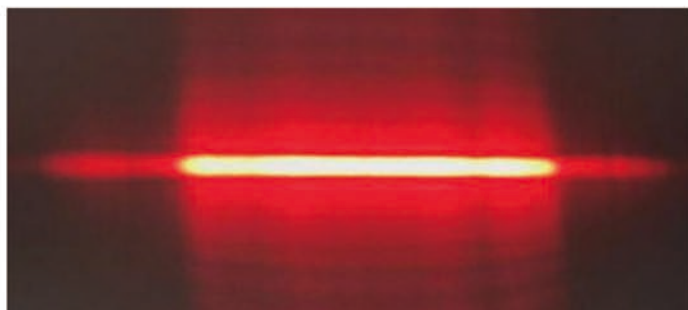

■ Outline Dimension

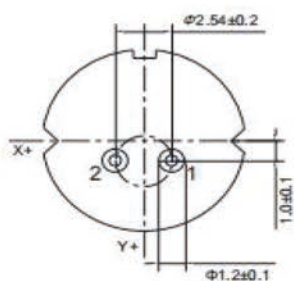
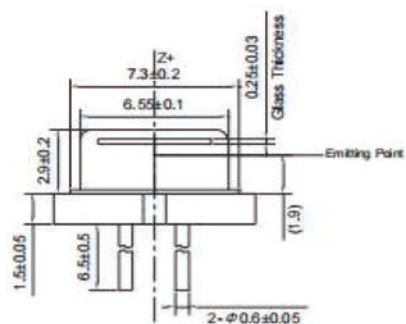
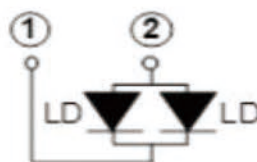
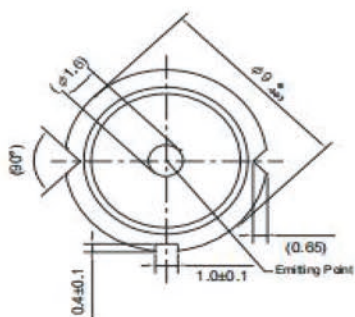

Unit: mm